



# WORLDWIDE ELECTRIC MOTOR DATA SHEET

## NAT13-36-56CB



HORSEPOWER	1/3 (1/4)		
RPM / POLES	3600 / 2 (3000 / 2)		
VOLTAGE / PHASE	230/460 V / 3 (190/380 V / 3)		
FRAME	56C		
ENCLOSURE / DEGREE OF PROTECTION	TEFC / IP43		
FREQUENCY	60 HZ (50 HZ)		
FULL LOAD SPEED	3450 RPM (2850 RPM)		
SERVICE FACTOR	1.15 (1.0)		
INSULATION CLASS	F		
FULL LOAD AMPS; 230 / 460 (190 / 380)	1.3 / 0.65 A (1.2 / 0.6 A)		
EFFICIENCY / POWER FACTOR	<u>LOAD</u>	<u>EFF.</u>	<u>P.F.</u>
	100%	60.0%	0.75
DUTY CYCLE	Continuous		
MAX. AMBIENT TEMPERATURE	40° C		
MAX. ELEVATION	3300 Ft. Above Sea Level		
TEMPERATURE RISE (At Full Load)	80° C		
DE BEARING	6203		
ODE BEARING	6203		
REGREASING INT. - DE BEARING	---		
REGREASING INT. - ODE BEARING	---		
GREASE TYPE	Mobil Polyrex EM		
MOUNTING	F1		
ROTATION	Bi-Directional		
CONNECTION DIAGRAM	230/460 V (190/380 V) - 9 Lead		
APPROXIMATE WEIGHT	18 lbs.		
INVERTER RATING	4:1 CT / 10:1 VT PWM Type		
OPTIONS / ACCESSORIES	Base	NBASE56-2	
	Capacitor (Start)	---	
	Capacitor (Run)	---	
	Capacitor Cover (Start)	---	
	Capacitor Cover (Run)	---	
	Centrifugal Switch	---	
	Endbell (DE)	NDEEBELL56-1	
	Endbell (ODE)	NODEEBELL56	
	Fan	NFAN56	
	Fan Cover	NFCOVER56	
	Junction Box	NJBOX56	
Stationary Switch	---		





# WORLDWIDE ELECTRIC MOTOR DRAWING

## NAT13-36-56CB

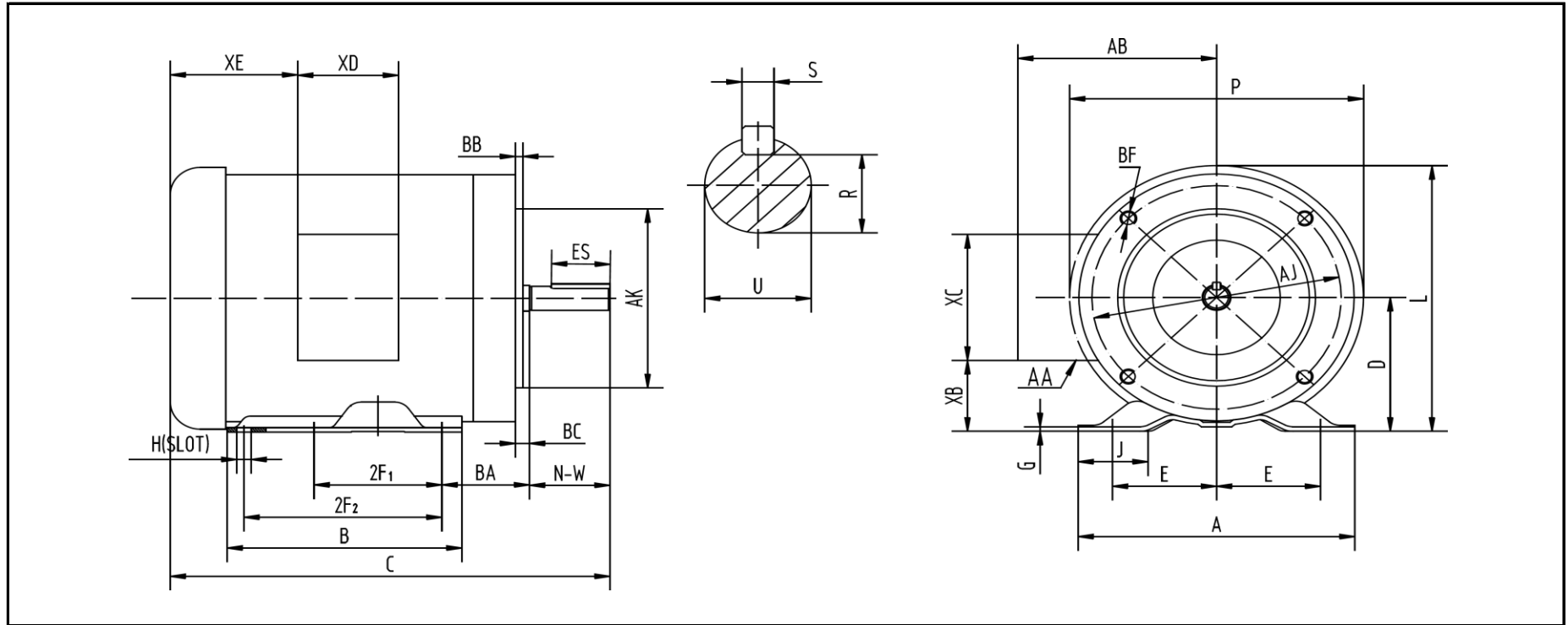

**DIMENSIONS - INCHES**

MOUNTING					A	B	C	D	G	J	L	P	AB	BC
E	2F1	2F2	H	BA										
2.44	3	5	0.34	2.75	6.54	6.54	11.9	3.5	0.1	1.65	7.4	7.3	5.2	-0.19

KEY		KEYSET	FLANGE				SHAFT		TERMINAL BOX				
S	ES	R	AK	AJ	BF	BB	N-W	U	AA	XB	XC	XD	XE
0.188	1.41	0.517	4.5	5.875	3/8-16	0.16	1.88	0.625	3-0.88 / 2-1.109	1.65	3.7	3.2	2.15